

Nikon

F3

INSTRUCTION MANUAL

NOMENCLATURE

① Shutter-speed dial locking button

② Depth-of-field preview button

③ Mirror lockup lever

④ Neckstrap eyelet

⑤ Self-timer LED

⑥ Backup mechanical release lever

⑦ Exposure memory lock button

⑧ Lens mounting flange

⑨ Reflex mirror

ADR window ⑭

ASA film speed/
Exposure compensation dial ⑮

Film rewind knob ⑯

Sync terminal ⑰

Lens mounting index ⑱

Lens release button ⑲

Meter coupling lever
release button ⑳

Meter coupling lever ㉑

Viewfinder illuminator ㉒

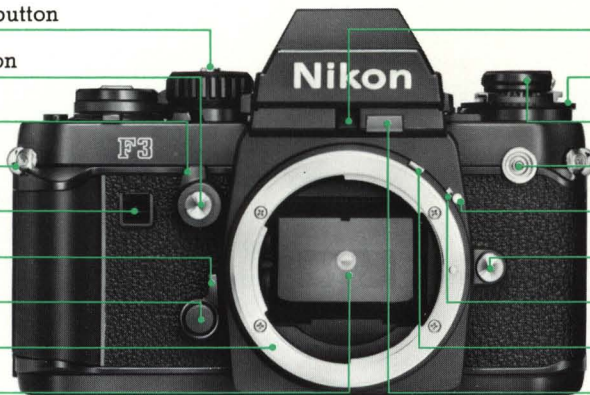

⑩ Motor drive coupling

⑪ Motor drive
positioning hole

⑫ Film rewind button

⑬ Memo holder

Tripod/Motor drive
coupling socket ㉓

Motor drive
electrical contacts ㉔

Battery chamber lid ㉕

Motor drive
coupling cover ㉖



27 Depth-of-field indicators/Mounting ring

28 Focusing ring

29 Aperture ring

30 Meter coupling ridge

31 Finder mounting/release levers

32 Exposure compensation scale

33 Exposure compensation index

34 Film rewind crank

35 Hot-shoe contacts

36 Accessory shoe

37 Camera back lock lever

38 Exposure compensation locking button

39 ASA film-speed scale

40 Eyepiece shutter lever

41 Viewfinder eyepiece

42 Shutter speed index

Aperture/Focusing index 43

Meter coupling shoe 44

Distance scale 45

Aperture-direct-readout scale 46

Viewfinder illuminator button 47

Self-timer lever 48

Self-timer ON index 49

Power switch ON index 50

Power switch 51

Multiple exposure lever 52

Shutter release button 53

Frame counter 54

Film advance lever 55

Shutter-speed scale 56

Shutter speed dial 57

Film plane indicator 58

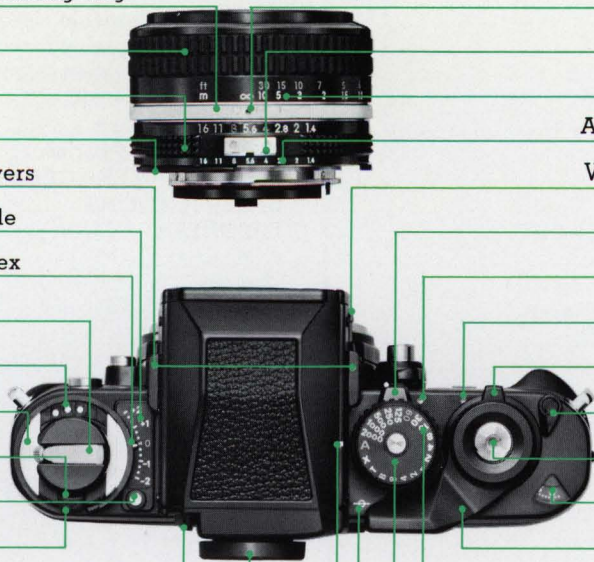

TABLE OF CONTENTS

NOMENCLATURE	2-3
FOREWORD	5
BASIC OPERATION	6-16
CONTROLS IN DETAIL	17-31
Shutter speed dial	17-19
Exposure memory lock button	20
Exposure compensation dial	21
ASA film speed dial	21
Memo holder	22
Shutter release button	22
Film advance lever	23
Frame counter	23
Multiple exposure lever	24
Batteries	24
Backup mechanical release lever	25
Depth-of-field preview button	25-26
Meter coupling lever	27
Mirror lockup lever	28
Self-timer	28
Eyepiece shutter lever	29
Accessory shoe	29
Sync terminal	30
Viewfinder illuminator	30
Film plane indicator	31
Infrared focusing index	31

ABOUT THE LIQUID CRYSTAL DISPLAY (LCD)	32
EV RANGE OF THE CAMERA	33-35
ACCESSORIES	36-41
Interchangeable viewfinders	36
Interchangeable focusing screens	37
Focusing screen selector guide	38
Motor Drive MD-4	39
Speedlights	40
Other accessories	41
TIPS ON CAMERA CARE	42-43
SPECIFICATIONS	44-45
IMPORTANT	46

FOREWORD

*Congratulations! You now own one of the most advanced and easy-to-use cameras on the market today. With a wealth of exciting new features, the Nikon F3 is designed to be as up-to-date as you are in your approach to photography. However, before actually taking pictures with the F3, you should familiarize yourself with its basic operation as presented in the first section. For more detailed explanations and special picture-taking situations, refer to the second section, **CONTROLS IN DETAIL**. A few minutes wisely invested now will pay off in years of rewarding photographic experiences.*

BASIC OPERATION



1. Remove the battery chamber lid 25.

Use a coin to twist the lid counter-clockwise to unscrew it.

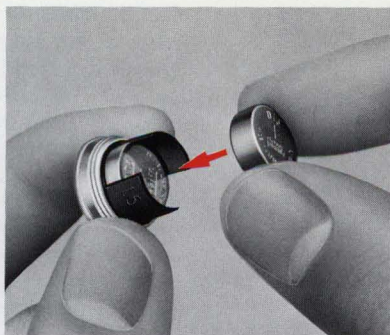

2. Install the batteries.

Insert the two 1.5V silver-oxide batteries supplied with the camera, making sure that the "+" signs are up.



3. Replace the battery chamber lid.

Slip the battery clip back into the camera body and screw it tightly into place.



4. Move the power switch ⁽⁵¹⁾ to uncover the red dot ⁽⁵⁰⁾.

This turns the camera on and makes it ready for exposure reading and shooting.

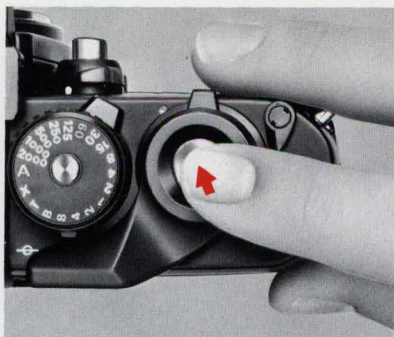

5. Touch the shutter release button ⁽⁵³⁾ lightly.

This activates the exposure meter. The meter stays on for 16 seconds after you take your finger off the button and turns itself off automatically to conserve battery power.

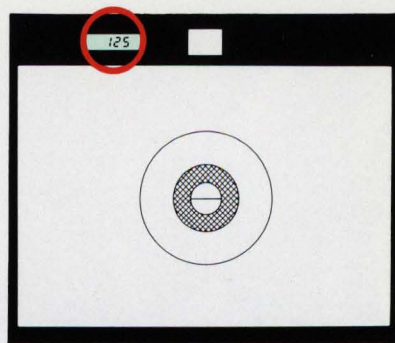

6. Check battery power.

Look through the viewfinder ⁽⁴¹⁾ at the liquid crystal display (LCD). The shutter speed should be displayed to show that the batteries have been properly installed and their power is adequate. If not, replace both batteries.

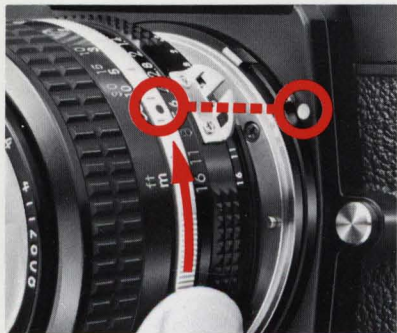

7. Mount the lens onto the camera.

Grasp the lens by its mounting ring (27). Then line up the focusing index (43) on the lens with the white dot (18) on the camera body and twist the lens counterclockwise until it clicks into place.

To remove: Push the lens release button (19) and turn the lens clockwise until it comes off.

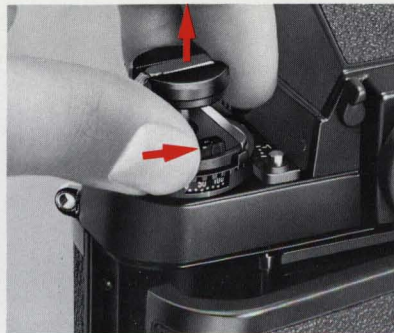

8. Open the camera back.

Push the camera back lock lever (37) to the right with your thumb while lifting the film rewind knob (16). The camera back will pop open.

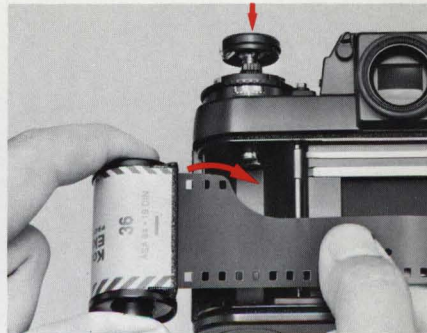

9. Install the film cartridge.

Drop the film cartridge into the film cartridge chamber so that the film leader points towards the takeup spool, and push the rewind knob back down into place.



10. Insert the film leader in the takeup spool.

Pull the leader across the camera and insert it into one of the slots in the film takeup spool.

Note: The two data back contacts located inside the camera below the film guide rails are for use with a data back available in the future.



11. Wind the film advance lever Ⓢ to advance film onto the takeup sprocket.

Wind the film advance lever and depress the shutter release button until the film sprockets engage the perforations on the edges of the film.

BASIC OPERATION—continued



12. Close the camera back.

Close the camera back until it snaps shut.



13. Take up the film slack.

Fold out the film rewind crank ⁽³⁴⁾ and rotate it in the direction of the arrow until it stops. Then fold the crank back in.



14. Make blank exposures until the frame counter ⁽⁵⁴⁾ shows "1."

Continue to wind the film advance lever and depress the shutter release button until the frame counter shows "1." While making blank exposures, watch the rewind knob to see that it rotates. This indicates that the film has been loaded correctly and is being advanced.



15. Set the ASA film speed.

Lift up the ASA film speed dial ⑮ and rotate it in either direction until the white dot is opposite the ASA film speed in use. Also make sure the exposure compensation dial is set to the red "0." This programs the camera's exposure meter so that it may provide a proper exposure for the type of film being used.

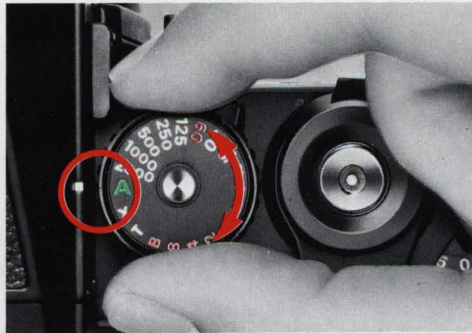

16. Set the camera for automatic operation.

Rotate the shutter speed dial ⑮ until the "A" is opposite the white dot ⑭. The built-in locking mechanism ensures that the dial cannot be accidentally shifted from the auto position during shooting.

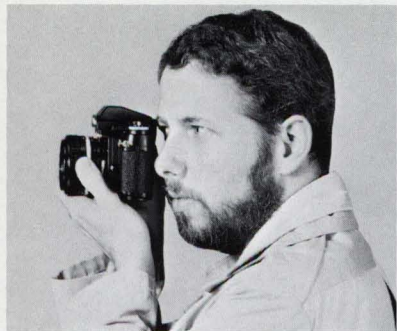

17. Hold the camera steady.

Wrap the fingers of your right hand around the camera body so that the index finger rests comfortably on the shutter release button and the thumb fits between the body and film advance lever.

Then, cradle the camera in the left hand with the thumb and fingers grasping the lens focusing ring ⑳. The camera may be switched from horizontal- to vertical-format shooting in this position.



18. Focus on the subject.

Turn the lens focusing ring until the image in the viewfinder becomes sharp.

The K focusing screen comes with the camera as standard equipment. With the split-image rangefinder, turn the ring until the split image becomes whole. With the microprism grid, turn the ring until the shimmering image appears sharp. With the matte outer field, turn the ring until the image appears sharp. The split-image rangefinder works well for subjects having definite lines or boundaries. The microprism collar is for fast-moving subjects or ones with indistinct lines, while the matte outer field is suitable for close-ups. In fast-moving or candid shooting situations, you can measure or estimate the distance between you and the subject and preset it on the lens using the distance scale ㉔ engraved both in feet and meters.

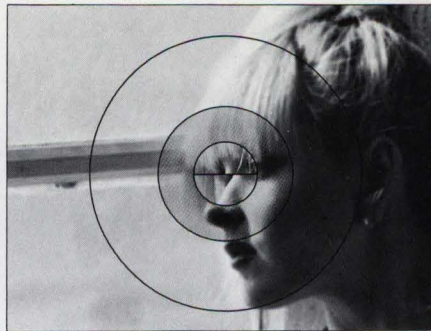

Out of focus

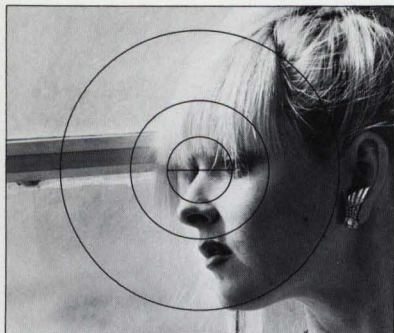

— In focus —

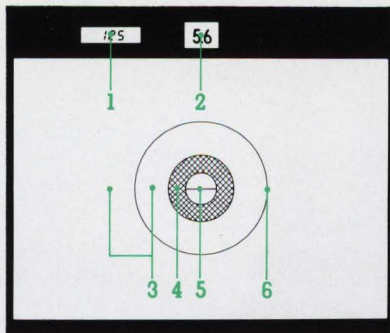

— Inside the viewfinder —

1. LCD exposure information
2. ADR f/number
3. Fine matte/Fresnel outer field
4. Microprism collar
5. Split-image rangefinder spot
6. 12mm ϕ reference circle

Note: The meter reads the light over the entire focusing screen but is distinctly biased toward the central 12mm ϕ area.



19. Set the lens aperture.

Turn the lens aperture ring (29) until the desired f/number is opposite the index mark on the lens. The selected f/number appears in the viewfinder for convenient reference.

BASIC OPERATION—continued



20. Take the picture.

Look through the viewfinder and press the shutter release button lightly to turn on the exposure meter. The shutter speed display indicates the shutter speed selected by the camera. As long as neither +2000 nor -8 appears in the shutter speed display, the camera gives the correct exposure. If either indication appears, adjust the aperture ring on the lens until a desirable shutter speed is indicated. Should either indication appear even after all possible lens apertures have been tried, then the available light is too bright or too dim for the meter's range. Use either artificial light to increase the subject's brightness or a neutral density filter to reduce the amount of light reaching the film.



21. Advance the film.

Stroke the film advance lever to transport the film to the next frame and get the camera ready for the next shot.



22. Push in the rewind button ⑫.

After the last exposure has been made, the film advance lever will stop working. You must then rewind the exposed film back into its cartridge. To do this, first turn the camera upside down and depress the rewind button to disengage the film sprocket drive.

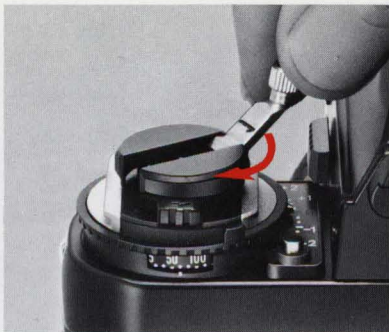

23. Rewind the film.

Lift the film rewind crank and turn it in the direction of the arrow to rewind the film. When you feel the tension lessen, continue winding one or two more turns until the film leader is rewound completely back into the cartridge.

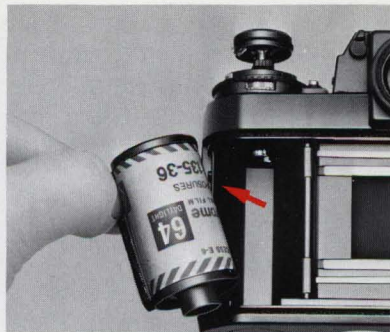

24. Remove the film cartridge.

Open the camera back and take out the film cartridge. Avoid unloading the film in direct sunlight. If there is no shade available, turn your back on the sun and use your own shadow to shield the camera while unloading film.

BASIC OPERATION—continued



25. Turn the camera off.

To conserve battery power between takes, return the power switch to the "off" position.

CONTROLS IN DETAIL

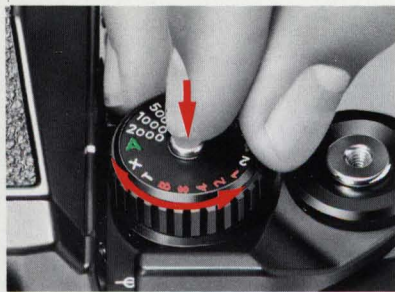

Shutter speed dial 57

In addition to automatic stepless shutter speed control, the Nikon F3 offers manual control of all shutter speeds from 1/2000 sec. to 8 sec. including X, B, and T. To move the shutter speed dial off "A," depress the locking button ① as you rotate the dial counterclockwise to the 1/2000 sec. setting. You can then rotate the dial freely between any setting except "X" which, like "A," is a locked setting. Shutter speeds from 1/2000 sec. to 1/2 sec. are engraved in white, 1 to 8 seconds and "B" in orange, and "T" and "X" in white. 1/60 sec. is in red, indicating the highest manual shutter speed for proper synchronization with electronic flash except "X."

When the camera is on manual, an "M" appears to the left of the liquid crystal shutter speed display inside the viewfinder. In addition, above the "M," the following symbols appear: "-", "+" and "- +" indicating underexposure, overexposure and correct exposure, respectively. To obtain correct exposure, simply turn the shutter speed dial and/or aperture ring until the "- +" symbol appears.

	Underexposure
	Overexposure
	Correct exposure



The F3 has two separate settings for time exposures. On "B," the shutter remains open for as long as the shutter release button is depressed. On "T," the shutter stays open until the dial is rotated to another setting, making it ideal for really long time exposures. Being a mechanical setting, "T" will not cause battery drain regardless of how long the shutter remains open.

"X" provides a shutter speed setting of 1/80 sec. It is used to provide proper synchronization with electronic flash units other than the Nikon SB-12.

The amount of light reaching the film plane is determined by a combination of the shutter speed and the lens aperture. Since the two are interrelated, different combinations will give the same degree of exposure. A one-step change in shutter speed, or a one-stop change in aperture setting, will either halve or double the degree of exposure. For example, a shutter speed of 1/125 sec. lets in twice as much light as a setting of 1/250 sec., and only half as much light at 1/60 sec. For an aperture setting of f/11, twice as much light as f/16 and half as much as f/8, is let in. Thus, if the correct exposure for a particular picture-taking situation is 1/125 at f/11, then 1/60 at f/16 or 1/250 at f/8 will give the same exposure. The following table illustrates the interrelation between shutter speed and aperture.

Shutter speed (sec.)	1/1000	1/500	1/250	1/125	1/60
Aperture (f/number)	4	5.6	8	11	16

The best combination will depend on the results you want. Use fast shutter speeds to freeze motion; use slow speeds to produce a deliberate blur. (See the example pictures on the opposite page.). Also, small apertures give greater depth of field, while large apertures restrict sharp focus to the main subject. (See page 26.)

A good rule to follow in preventing camera shake is to select a minimum shutter speed which is the reciprocal of the focal length of the lens in use. For example, when using a normal 50mm lens, select a speed no slower than 1/60 sec. (the closest number to 1/50). For a 500mm super-telephoto, use no less than 1/500 sec., and so forth.

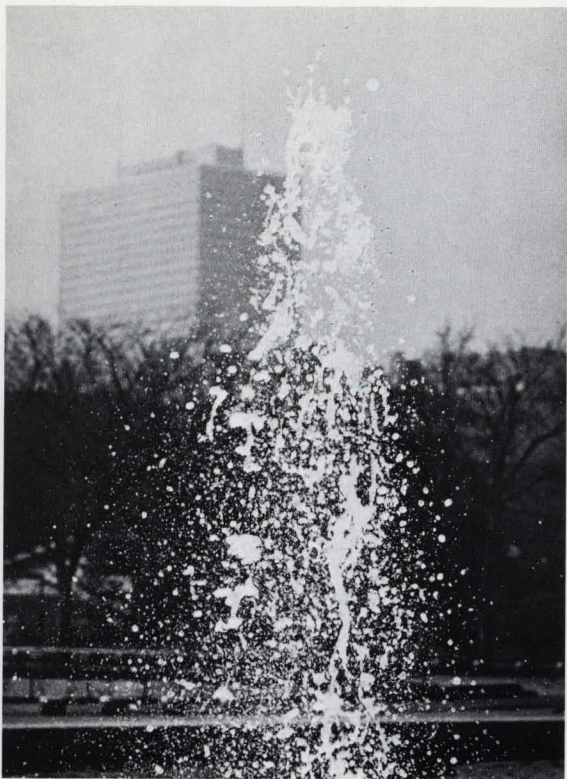

(Stop action)

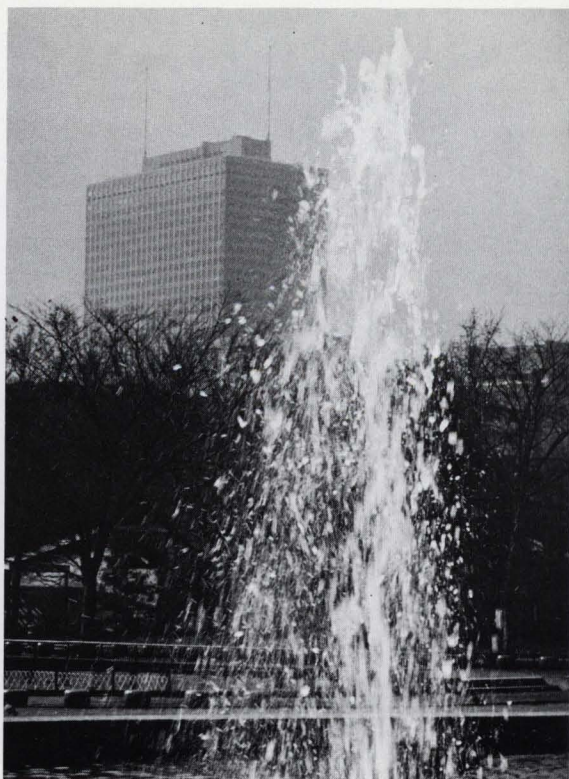

(Subject motion blur)

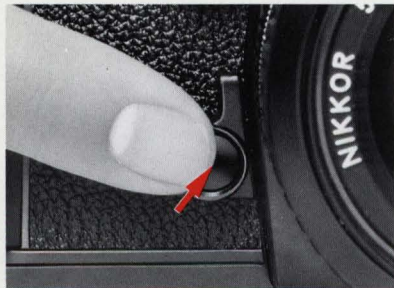

Exposure memory lock button ⑦

When there is a substantial difference between the main subject and the background, unimportant bright spots or dark spots are likely to fool the camera's metering, resulting in under- or overexposure (see Fig. 1). One way to make exposure compensation is to use the memory lock. This control allows you to lock in an exposure reading with the camera on automatic control. To compensate for an excessively bright or dark background, center the main subject in the viewfinder or move in close to the subject, depress the memory lock button and hold it in; then recompose and shoot (see Fig. 2).

250

5.6



(Fig. 1)

50

5.6



(Fig. 2)

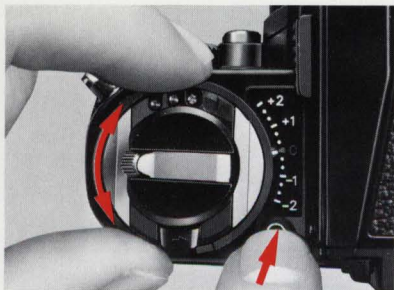

Exposure compensation dial 15

Another way to correct exposure is to use this dial. Push the locking button 39 while rotating the dial. The dial is graduated in one-third stop increments. -1 and -2 indicate one and two stops underexposure, whereas +1 and +2 indicate one and two stops overexposure.

At ASA 6400, the compensation extends to only -1; at ASA 12, up to +1. The following table indicates the recommended settings for various subjects. After use, make sure you set the dial back to "0."

Original Type of film	Repro-copying & slide-copying			Photo- micrography
	B & W color photo	Letters or figures on light background	Letters or figures on dark background	
Panchromatic film for general use	No compensation necessary	+ 1-1/3 stops	-2/3 stop	+ 1 stop



ASA film speed dial 15

The scale 39 on the ASA dial has numbered settings for speeds from ASA 12 to 6400. Two dots between each pair of ASA numbers stand for intermediate settings, such as 64, 80, etc. The table below gives the speeds for all intermediate settings.

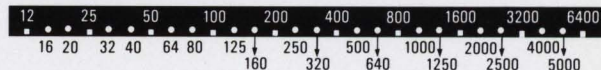

ASA is a numerical rating of the film's sensitivity to a given amount of light. The higher the number, the greater the sensitivity, and vice versa. The ASA of your film is indicated on the cartridge itself. It is also printed on the film carton and on the data sheet packed inside.



Memo holder ⑬

As a reminder of the film type and the number of exposures on the roll in use, clip off the end of the film carton and insert it into the memo holder.

Note: At the "B" setting, unless you hold the shutter release button down all the way, the shutter may close prematurely.



Shutter release button ⑬

Slight pressure on the shutter release button switches on the exposure meter. Pushing the button all the way down releases the shutter. The shutter release button is threaded at the center to accept a standard cable release.

When battery power fails, the F3's electromagnetically controlled shutter ceases to operate. You cannot release the shutter release button unless you use the backup mechanical release lever ⑮.

To lock the shutter release button when the camera is not in use, turn the power switch to the "OFF" position.

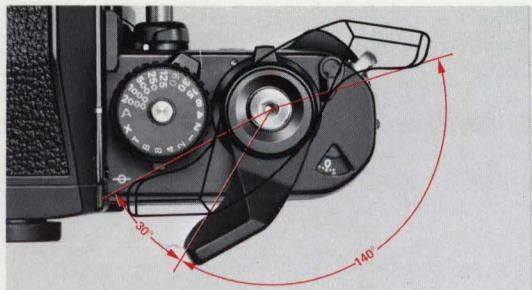

Film advance lever (55)

The film advance lever is specially contoured to fit the thumb and is coaxial with the shutter release button. It has a 30° stand-off with a throw of 140° and may be operated in one complete stroke or a series of shorter ones.



Frame counter (54)

To keep track of the number of exposed frames, the frame counter is graduated from two frames below 0 up to 40. Blue numerals appear every 5 frames (0, 5, 10, etc.) with dots in between. White marks at 12, 20, 24, and 36 indicate the number of frames available on most film cartridges. When making blank shots with the shutter speed dial set to "A," the shutter will fire at 1/80 sec. until the frame counter reaches "1." In addition, the LCD shows 80 in the finder. Or if you set the dial manually between 1/125 and 1/2000 sec., the shutter will still fire at 1/80 sec. In the finder, an "M80" is displayed. However, if the speed is manually set to 1/80 sec. (X) or below, the shutter will fire at the speed set and the speed will be displayed by the LCD. Therefore, to speed up film loading, set the dial to "A" or to 1/80 sec. (X) or above. "T" should not be used when making blank shots as the shutter will remain locked open.

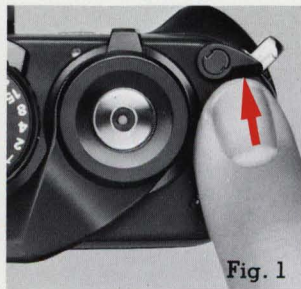

Fig. 1

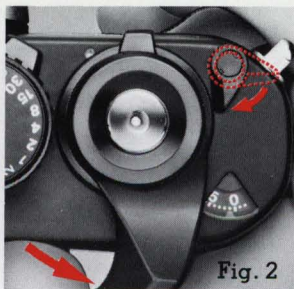

Fig. 2

Multiple exposure lever 52

Double or multiple exposures are easy to accomplish with the F3's multiple exposure lever. Follow this procedure:

1. Take the first shot.
2. Then to recock the shutter without advancing the film, push the multiple exposure lever forward (Fig. 1), and stroke the advance lever. Immediately the multiple exposure lever will spring back to its normal position (Fig. 2).
3. Now you're ready to take the second shot on the same frame. For more than two shots on the same frame, just repeat the same procedure for each additional exposure. When you've finished, simply advance the film normally to the next frame.

Note: While making multiple exposures, the frame counter doesn't advance.

Batteries

When battery power fails, the camera's exposure meter stops working and the shutter won't work either unless you use the backup mechanical release lever. For this reason, it is a good idea to carry an extra set of batteries with you whenever you set out to take pictures.

Under normal usage, one set of 1.5V silver-oxide batteries (Eveready EPX76 or equivalent) will last for about one year. Try not to touch the + or - surfaces of the batteries as this may result in poor electrical contact. If you do get fingerprints on the battery terminals, wipe them off with a soft cloth.

At below-freezing temperatures, battery performance deteriorates. The use of a fresh set of batteries is recommended to ensure reliable service at low temperatures. In extremely cold climates, it is recommended to use the F3 in conjunction with the MD-4 Motor Drive. With the motor drive attached, the camera gets all its power from the batteries in the motor drive. Thus, if you use a NiCd battery, the camera/motor drive will operate down to -20°C .

Note: At -10°C or below, the LCD may exhibit a slight delay in response time. This is natural and should be no cause for concern. However, exposure to extremely high temperatures (80°C and above) may actually shorten the life of the LCD.

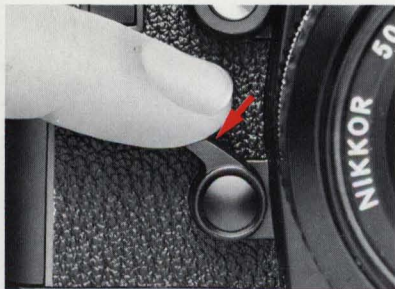

Backup mechanical release lever ⑥

This lever is provided as an alternative method of tripping the shutter in case the camera's batteries become weak or completely exhausted. To operate the lever, first use your fingernail to pull it down to the ready position. Then push it down to trip the shutter. The shutter operates at a mechanical speed of approx. 1/60 sec. regardless of the setting on the shutter speed dial. Even when the batteries are exhausted, you can still make time exposures by setting the dial to "T" and using the backup mechanical release lever to trip the shutter.

Caution: *If you advance the film while holding down the backup mechanical release lever, the shutter will fire immediately at the completion of the film advance stroke, thus wasting a frame.*

Also if you fail to advance the film completely and then use this lever to trip the shutter, the mirror ⑨ will remain in the "up" position until the advance lever stroke is completed.

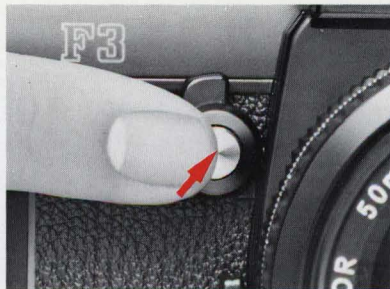

Depth-of-field preview button ②

This control allows you to get a visual impression of the various parts of the scene in front of and behind the main subject which will appear sharp in the final photograph (see the photos on the next page.) To operate this control, push the button while looking through the viewfinder. If the lens is set to anything other than maximum aperture, the image on the focusing screen will give you an indication of exactly what will be in focus in the final photo. The image progressively gets darker as the lens aperture gets smaller.



Lens set at $f/2.8$



Lens set at $f/16$

At wide apertures, the depth-of-field is very shallow with the main subject in focus. But when the lens is stopped down to $f/16$, most objects from near to far are in sharp focus.

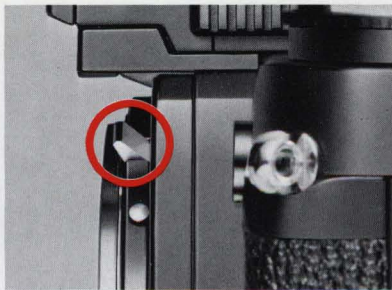
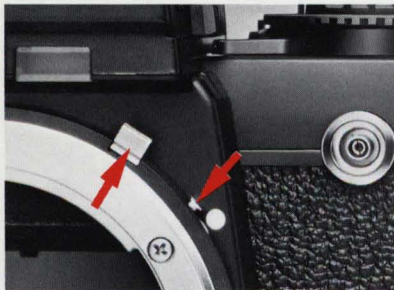

Meter coupling lever ⑳

Push the meter coupling lever release button ⑳ and lock the meter coupling lever in the "up" position before mounting a non-AI Nikkor lens. Then perform stopped-down metering in the following manner:

For non-AI Nikkor lenses with automatic diaphragms

On AUTO: Push in and hold the depth-of-field preview button while you trip the shutter.

Caution: If the depth-of-field preview button is not depressed all the way, the mirror may remain in the "up" position.

On MANUAL: Select a shutter speed. Then hold in the preview button and turn the aperture ring until the "- +" symbol appears in the finder. Release the preview button and take the shot.

For non-AI lenses or accessories without automatic diaphragms

On AUTO: Stop the lens down manually until the desired shutter speed appears in the finder. Then take the picture.

On MANUAL: Adjust the shutter speed or aperture until the "- +" sign appears.

For fixed-aperture reflex lenses, photomicrography, or astrophotography

On AUTO: No control is necessary.

On MANUAL: Adjust the shutter speed dial until the "- +" appears.

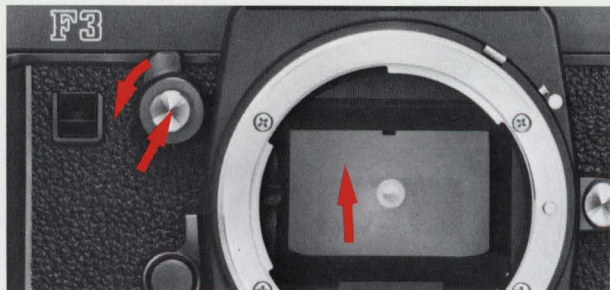

Mirror lockup lever ③

When using super-telephoto lenses or doing photomicrography, it becomes necessary to reduce camera vibration to the absolute minimum. To lock the reflex viewing mirror in the "up" position, push in the depth-of-field preview button and rotate the lever counterclockwise until it stops.

Note: Two Nikkor lenses require that the mirror be locked up before mounting—the Fisheye-Nikkor 6mm f/5.6 and OP Fisheye-Nikkor 10mm f/5.6.

Caution: With the mirror locked up, you should not operate the camera on automatic. Even though the LCD continues to show you the shutter speed automatically selected by the camera, this speed will not produce the correct exposure.

Self-timer

The F3's blinking self-timer provides a 10-sec. delay in shutter release.

To operate the self-timer:

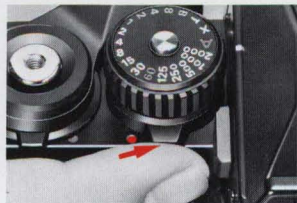

1. Push the self-timer lever ④⑧ to uncover the red dot ④⑨.



2. Push the shutter release button.



3. Watch the blinking red LED ④⑤ on the front of the camera. The LED blinks faster during the final two seconds before the shutter opens to warn you to get ready.

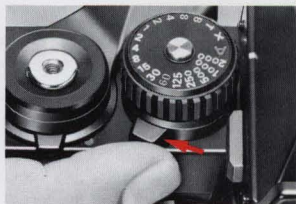

4. Don't forget to return the self-timer to its original position after using it. If you want to cancel the self-timer after pushing the shutter release button, return the self-timer lever to its original position. The picture then will not be taken.

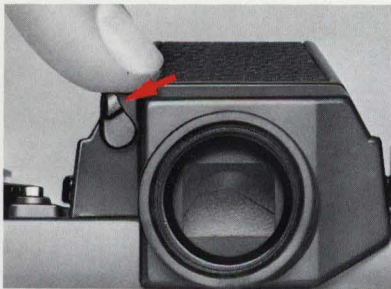

Eyepiece shutter lever ④①

When it's impossible to keep your eye at the viewfinder (such as when utilizing the self-timer), you should use the eyepiece shutter. This shutter prevents stray light from entering the eyepiece and adversely affecting the automatic exposure meter reading. Just push the lever to the left to close the shutter. As a visual reminder that it's in use, the blind is painted red.



Accessory shoe ③⑥

Located at the base of the rewind knob, the accessory shoe allows direct mounting of the Nikon SB-12 Speedlight. Three electrical contacts ③⑤ provide for synchronization of the flash unit, automatic through-the-lens flash output control, and ready-light indication in the camera's viewfinder (via an LED), plus auto switching to the proper synchronization speed of 1/80 sec. Two flash coupling adapters are available allowing either ISO- or Nikon F2-type direct-mounting electronic flash units to be attached.



Sync terminal ⑰

A separate sync terminal with a protective screw-in cover is provided on the Nikon F3. It accepts all standard plug-in PC cords, plus it is threaded for use with a Nikon screw-in PC cord. When using flash bulbs or an electronic flash without a hot shoe, it is necessary to use the sync terminal. Use the following table to determine the correct synchronization speed to set on the camera.

		Shutter speed (sec.)																	
		1/2000	1/1000	1/500	1/250	1/125	1/60	1/30	1/15	1/8	1/4	1/2	1	2	4	8	X(1/60)	B	
Flashbulb	FP	Synchronized						Cannot be used											
	M	Synchronized						Cannot be used											
	MF	Synchronized						Cannot be used											

Synchronized
 Cannot be used



Viewfinder illuminator ⑳

A convenient built-in viewfinder illuminator lets you see the liquid crystal display shutter speed, including the aperture, even in dim light. While the LCD is displayed in the finder, push the illuminator button ⑳.

Note: The power switch must be turned on and the shutter button must be depressed halfway prior to using the illuminator. Otherwise, it will not light up.



Film plane indicator ⑤⑧

The film plane indicator (↔) is engraved in white on the top deck just behind the shutter speed dial. It indicates the exact position of the film plane inside the camera. Whenever it becomes necessary to measure the exact distance between the subject and film plane, such as in macrophotography, use the film plane indicator. The distance between the film plane and the lens mounting flange ⑧ is exactly 46.5mm.



Infrared focusing index

The red dot beside the focusing index on most lenses is the infrared focusing index. When shooting with black-and-white infrared film, it is necessary to refocus the lens to compensate for the fact that infrared light rays focus at a point slightly in front of visible light. To use the index, first focus on your subject through the viewfinder. Then look at the lens and take note of the focused distance. Finally reset the focusing ring so that the desired distance is aligned with the red dot.

ABOUT THE LIQUID CRYSTAL DISPLAY (LCD)

1. At high temperatures (over approx. 60°C), the whole surface turns black so that the exposure information cannot be read. However, this situation will return to normal when the temperature drops.
2. Avoid storing the camera in excessively hot places, such as in a car parked in direct sunlight or inside the trunk. You may shorten the LCD's life by doing so.
3. When the temperature goes below freezing, the response time decreases as the liquid crystal becomes more viscose.
4. Although the Nikon F3 employs the highest quality LCD, it deteriorates in contrast and becomes difficult to see after six or seven years. When this happens, please contact your dealer or the Nikon service facility nearest you for replacement of this element at a small charge.

EV RANGE OF THE CAMERA

How to read the EV chart

■ Full-aperture metering

Example: Lens maximum aperture f/1.4
ASA film speed 100
Working aperture f/5.6

By referring to the f/1.4 column in Section A and the EV values indicated for ASA 100 in Section D, you will find that the EV range for an f/1.4 lens at ASA 100 is 1 to 18. Now, refer to Section B and single out the f/5.6 indication for ASA 100. Go diagonally down until the protruding line intersects with Section C's vertical line for the shutter speed of 8 sec. (the F3's slowest shutter speed). From this point of intersection, follow the horizontal line that leads to Section D's EV value for ASA 100, and you will obtain an EV value of 2. Start again from the f/5.6 indication for ASA 100 in Section B, and go down diagonally until the protruding line intersects with Section C's vertical line for the shutter speed of 1/2000 sec. (the F3's fastest shutter speed) this time. Then follow the horizontal line that leads to Section D's EV value for ASA 100, and you will get a reading of EV 16. This means that an f/stop of f/5.6 at ASA 100 and a shutter speed of from 8 to 1/2000 sec. has an effective EV range of 2 to 16, which is well within the F3's metering range of EV 1 to EV 18. The area encompassed by the heavy lines in Section C demonstrates a metering range for full aperture method using an f/1.4 lens and ASA 100 film.

■ Stop-down metering

Example: ASA film speed 100

Stopped-down aperture f/8

The procedure is the same. The f/8 column in Section A and the EV values indicated for ASA 100 in Section D will show you that the EV range for f/8 is 6 to 23. Refer now to Section B and single out f/8 at ASA 100. Go diagonally down until the protruding line intersects with Section C's vertical line for the shutter speed of 8 sec. From this point of intersection, follow the horizontal line that leads to Section D's EV value for ASA 100, and you will obtain an EV reading of 3. This means that an f/stop of f/8 at ASA 100 and a shutter speed of 8 sec. give an EV value outside the metering range. To find out the slowest shutter speed usable, follow the f/8 indication for ASA 100 in Section B diagonally down until it intersects the horizontal line in Section C that leads to Section D's EV value of 6 for ASA 100, and you will find that the slowest shutter speed usable is 1 sec. In other words, at f/8 and ASA 100, the available shutter speed range that is within the metering range is from 1 to 1/2000 sec., which has an effective EV range of 6 to 17 (indicated by the broken line in Section C)—well within the metering range.

In practice, you will find that it is generally the high end and the low end which require a careful check. The EV range of the Nikon F3 encompasses most lighting situations, and it is only under dim-light or extra-bright picture-taking situations that you need pay any special attention.

EV RANGE OF THE CAMERA—continued

The camera's meter may be used only within the shutter speed range covered by the exposure value (EV) range of the meter, which varies with the aperture and ASA settings.

The chart on page 35 shows the relationships between the f/stop, shutter speed and film speed, indicating the slowest functioning shutter speed (for metering purposes) with any film speed/aperture combination.

Careful attention to the following instructions will assure precise exposure, automatically, over the complete exposure control and meter range capability of your Nikon F3.

■ Auto exposure control at full aperture

For example, with an f/1.4 lens and ASA 100 film, the automatic shutter will function down to one second with the lens set at f/1.4, and proportionately slower as the aperture is closed.

Using a standard of ASA 25 film, you may be assured of at least a four-second speed regardless of the aperture of the lens used as long as the lens is set at full aperture (refer to Table).

Using ASA 400 at f/1.4, the slowest speed is 1/4 second; however, as the aperture is closed down, the functioning shutter speed becomes progressively slower until we reach f/8 when the slowest speed of eight seconds is functioning.

■ Auto exposure control with stop-down metering

When using a bellows or other extension equipment which disengages the meter coupling device, it is necessary to revert to stop-down metering. Certain limitations are imposed in this mode.

As lens-to-film distance is increased, the metering range (EV range) changes proportionately. For example, when an f/2 lens is used at 2:1 reproduction (twice life-size) the effective f/number is f/5.6. When used at f/8, the effective f/number is f/22.

When pictures are taken under minimal light levels, it is desirable to use a high-speed film (ASA 160 or higher). Using Tri-X at film speed 400 with stop-down metering, with an effective f/number of f/8, the shutter speed range would be from 1/4 second to 1/2000. Should the light level drop below EV 6, it would be out of the shutter speed range of the meter.

Table
Slowest shutter speed at full aperture with any lens

ASA speed	Slowest shutter speed (sec.)
6400	1/60
3200 (4000)	1/30
1600	1/15
800	1/8
400	1/4
200 (160)	1/2
100 (80)	1
50 (64)	2
25	4
12	8

EV Chart

Section A
Working Aperture

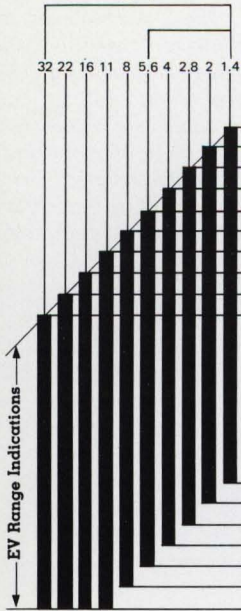

Section D

ASA									
6400	3200 (4000)	1600	800	400	200 (160)	100 (80)	50 (64)	25	12
7	6	5	4	3	2	1	0	-1	-2
8	7	6	5	4	3	2	1	0	-1
9	8	7	6	5	4	3	2	1	0
10	9	8	7	6	5	4	3	2	1
11	10	9	8	7	6	5	4	3	2
12	11	10	9	8	7	6	5	4	3
13	12	11	10	9	8	7	6	5	4
14	13	12	11	10	9	8	7	6	5
15	14	13	12	11	10	9	8	7	6
16	15	14	13	12	11	10	9	8	7
17	16	15	14	13	12	11	10	9	8
18	17	16	15	14	13	12	11	10	9
19	18	17	16	15	14	13	12	11	10
20	19	18	17	16	15	14	13	12	11
21	20	19	18	17	16	15	14	13	12
22	21	20	19	18	17	16	15	14	13
23	22	21	20	19	18	17	16	15	14
24	23	22	21	20	19	18	17	16	15
25	24	23	22	21	20	19	18	17	16
26	25	24	23	22	21	20	19	18	17
27	26	25	24	23	22	21	20	19	18
28	27	26	25	24	23	22	21	20	19
29	28	27	26	25	24	23	22	21	20
30	29	28	27	26	25	24	23	22	21

Section C

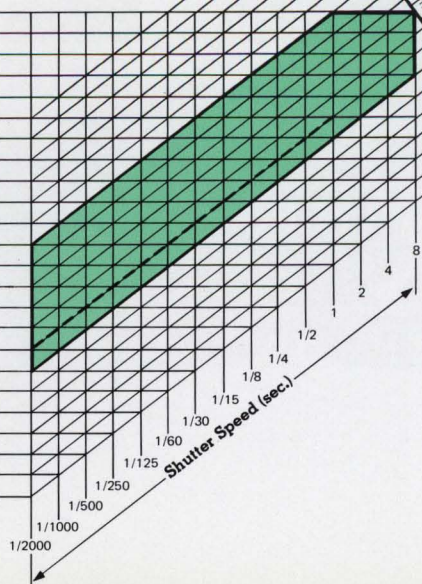

ASA		f/number set	
6400	1/4	1/2	1/2
3200 (4000)	1/5	1/3	1/3
1600	1/6	1/4	1/4
800	1/8	1/5	1/5
400	1/11	1/6	1/6
200 (160)	1/16	1/8	1/8
100 (80)	1/22	1/11	1/11
50 (64)	1/32	1/16	1/16
25	1/45	1/22	1/22
12	1/64	1/32	1/32

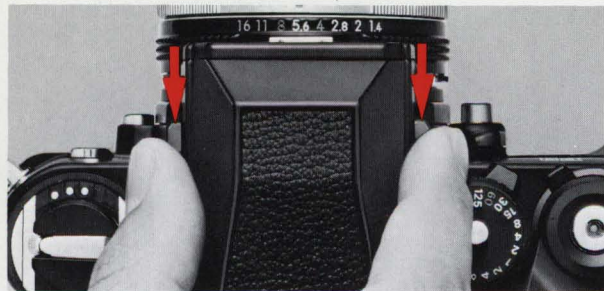

Fig. 1

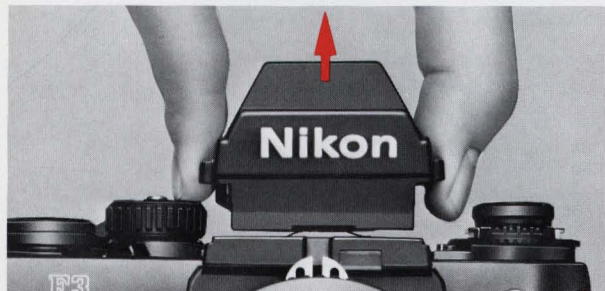

Fig. 2

Interchangeable viewfinders

In addition to the DE-2 Eye-Level Finder, the F3 accepts various other interchangeable viewfinders. To remove the finder, slide the finder release levers ③ with your thumb and finger towards the back of the camera (Fig. 1), and lift the finder out (Fig. 2). The DW-3 Waist-Level Finder is ideal when you want to use the camera at a low angle or upside down over your head for shooting over crowds. The DA-2 Action Finder works well for those situations when you can't bring your eye close to the finder, such as when you are wearing a helmet or goggles or when the camera is enclosed in a waterproof underwater housing. The DW-4 6X Magnification Finder is for critical high-magnification close-up work or photomicrography. Regardless of which finder is attached, you still have full automatic exposure control because the meter is built not into the finder but the body.

When using the DA-2 or DW-3, be careful that stray light does not enter from the top and cause an inflated meter reading.

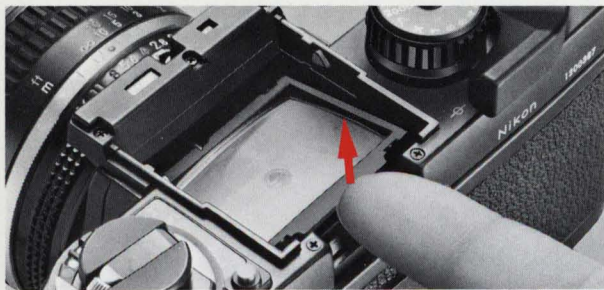

Fig. 1



Fig. 2

Interchangeable focusing screens

Nikon offers you a choice of 20 interchangeable focusing screens: A—T. The type K screen comes with the camera as standard equipment. On the following page is a chart listing all the screens.

To take out the focusing screen, first remove the finder, then insert your fingernail under the rear edge of the screen and lift it out (Fig. 1).

To install another screen, simply insert the front edge (the edge with the slot in the middle) under the pin and push the rear edge of the screen down into place (Fig. 2).

Note: For more information on which screens are compatible with which lenses, consult the instruction sheet supplied with the lens.

ACCESSORIES—continued

Focusing Screen Selector Guide



Type A: Matte/Fresnel field with 3mm ϕ circular split-image rangefinder spot and 12mm ϕ circle. Rapid and accurate focusing. Excellent for general photography.



Type B: Matte/Fresnel field with 12mm ϕ fine-ground matte focusing spot in the center. Good for general photography, especially with long lenses.



Type C: Fine-ground matte field with 4mm ϕ clear spot and cross hair. For photomicrography, astrophotography and other high-magnification applications, using parallax focusing on aerial images.



Type D: Overall fine-ground matte field. For specialized close-up photography and for use with long lenses.

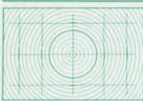

Type E: Matte/Fresnel field with 12mm ϕ fine-ground matte spot and etched horizontal and vertical lines. Ideal for architectural photography.



Type G: Clear Fresnel field with extra-bright 12mm ϕ microprism focusing spot for viewing and focusing in poor light. Four models (G1—G4) are available corresponding to specific focal length lenses. Depth of field cannot be observed.



Type H: Clear Fresnel field with microprism focusing pattern over the entire screen area. Permits rapid focusing on any part of the screen with optimum edge-to-edge brightness in poor light. Available in four models (H1—H4) corresponding to particular focal length lenses.

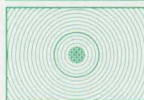

Type J: Matte/Fresnel field with central microprism focusing spot and 12mm ϕ circle. Good for general photography.



Type K: Combination of Type A and J screens. Matte/Fresnel field with 3mm ϕ split-image rangefinder spot surrounded by 1mm-wide microprism doughnut. Rapid and accurate focusing for subjects with both straight lines and ill-defined contours. Suitable for general photography.



Type L: Same as Type A screen but with split-image rangefinder line at a 45° angle. Best for subjects with horizontal lines.

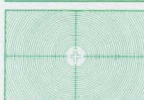

Type M: Fine-ground Fresnel field with 5.5mm ϕ clear spot and double cross hair for use in parallax focusing on aerial image, plus millimeter scales for calculation of individual magnification of objects or for measuring objects. Brilliant image in dim light. Suitable for close-ups, photomicrography and other high-magnification applications.



Type P: Same as Type K but with split-image rangefinder line at a 45° angle and etched horizontal and vertical lines as an aid to composition. Rapid and accurate focusing for subject with horizontal or vertical lines or ill-defined contours. Suitable for general photography.

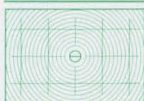

Type R: Same as Type A but with rangefinder prisms of sloping surfaces at a smaller angle and horizontal and vertical lines to aid proper composition. Works best with lenses having maximum apertures from f/3.5 to f/5.6.

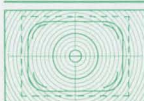

Type T: Matte/Fresnel field with split-image rangefinder, 12mm ϕ reference circle, and horizontal and vertical lines. Used when preparing slides for TV broadcasts. Dotted lines indicate standard TV screen format. Solid outline shows "safe action" area, whereas broken lines indicate "safe title" area.

Motor Drive

One of the most exciting new accessories for the F3 is the MD-4 Motor Drive. This amazingly compact and streamlined unit attaches to the bottom of the camera in seconds and advances the film either singly or in sequence form up to a rapid 6* frames per second—making it the fastest regular production motor drive on the market today. Actual controls have been reduced to only those necessary for convenient operation. In addition to the electromagnetic trigger button (which also turns on the camera's meter when depressed halfway), there is its concentric S-C (SINGLE/CONTINUOUS) mode selector, a battery check button and LED indicators, two interlocking rewind slides for automatic film rewinding, and a subtractive frame counter which stops the motor at the desired number of frames for use in cold weather. Eight AA-type penlight batteries fit into a quick-release clip housed in the base of the motor drive. An optional NiCd battery pack is available for use in cold weather or when you want the fastest possible firing rate. Once you attach the MD-4 to your camera, you'll never want to take it off.

* Possible with NiCd battery pack at 1/125 sec. or above with mirror locked-up.

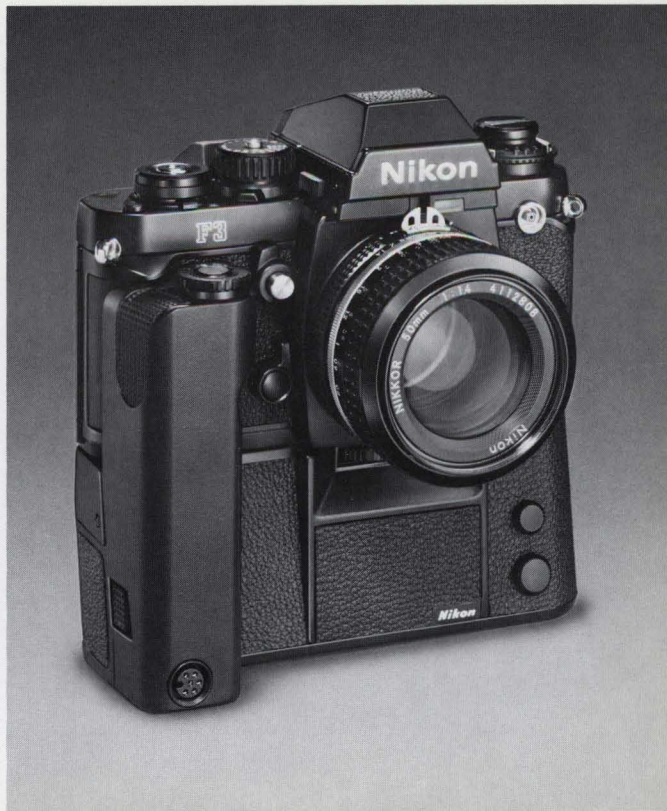

Speedlights

Designed to complement the versatility of the F3, the Nikon SB-12 is a direct-mounting electronic flash unit offering fully automatic through-the-lens flash output control. Even with the camera on automatic, the proper synchronization speed of 1/80 sec. is automatically set. Then, while the shutter is open, the camera's Silicon Photo Diode reads the light reflected off the film and tells the flash unit to cut itself off when the exposure is correct. With a guide number of 25 (ASA 100 and meters) or 40 (ASA 25 and feet), the SB-12 Speedlight provides just the right amount of light for subjects located between 0.6m—15m (2ft—49ft). As soon as the flash is recycled and ready to fire, an LED ready-light inside the finder goes on. The same LED blinks to let you know when the light is insufficient for proper exposure.

And for those photographers needing even more power and versatility, Nikon has created the SB-11 Speedlight. It has a guide number of 36 (ASA 100 and meters) or 60 (ASA 25 and feet) and gives you a choice of three automatic shooting apertures— $f/4$, $f/5.6$, and $f/8$ at ASA 100. When used with the F3 via a special TTL connecting cord, it provides the same automatic through-the-lens control of the flash exposure as the SB-12. Other features include a bounce head and a removable sensor for automatic use with other cameras.

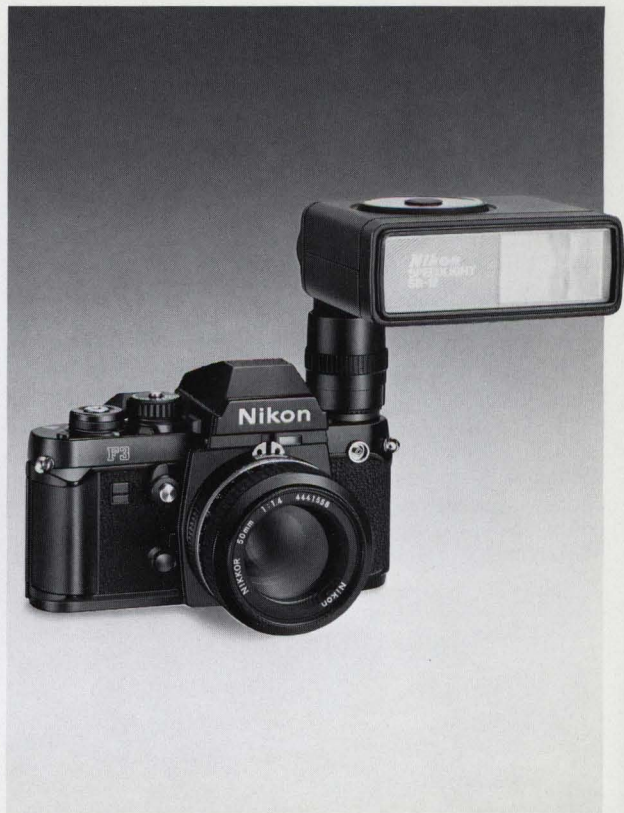

OTHER ACCESSORIES

Eyepiece Correction Lenses

Screwing into the finder eyepiece, nine separate lenses are provided, so that near- and farsighted photographers can use the F3 without their glasses. They are available in -5, -4, -3, -2, 0, +0.5, +1, +2, and +3 diopters representing the combined dioptery of the finder and lens.

Rubber Eyecup

The eyecup prevents stray light from entering the viewfinder from the rear, yet is still small enough not to cause any interference when closing the camera back. The eyecup also allows eyeglass wearers to use the F3 without fear of scratching their glasses.

Camera Cases

The CF-20 Semi Soft Leather Case was designed exclusively for the F3. And there are three new Custom Shoulder Cases (CB-1, 2, or 3) for the photographer who wants to carry his F3 in style.



TIPS ON CAMERA CARE

Camera care is common sense care. Treat your F3 as you would treat other valuable precision instruments. Even though the F3 is built to take many years of hard use, it may be damaged by shock, heat, water, or misuse. Following are some tips to help you keep your camera in good condition.

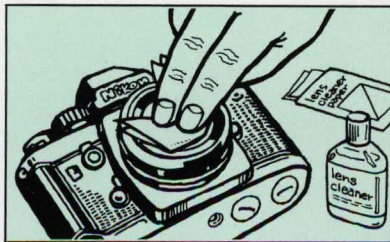

1. Keep the lens clean.

Keep the lens surfaces free of fingerprints and dust as much as possible. Remove dust with a blower brush or lens tissue. Never use cloth or ordinary tissue. If smudges or fingerprints persist, use lens tissue moistened sparingly with alcohol or lens cleaner.

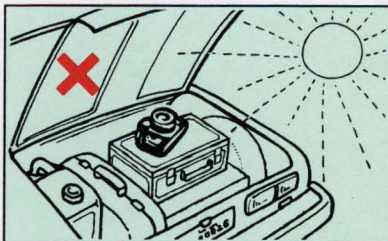

4. Do not expose the camera to high temperatures.

Keep the camera away from places where the temperature is apt to be high, such as on the beach under direct sunlight or in the trunk of a car.

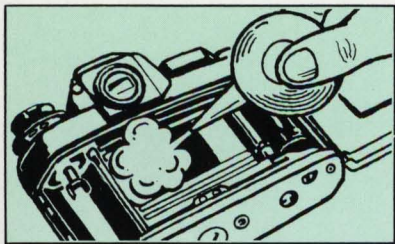

2. Clean the inside of the camera.

Brush out the inside of the camera periodically using a soft brush. Do not exert pressure on the shutter curtains as this may damage them. Also keep the mirror free from fingerprints and dust.



3. Keep the camera away from water.

Avoid excessive moisture. When using the camera near water, guard against splashes, especially saltwater spray.

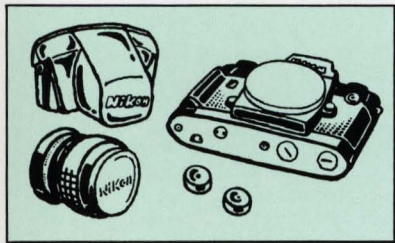

5. Store the camera properly.

Store the camera in a carrying case to protect it from dust. Avoid storing the camera in excessively hot, cold, or damp places. Always attach a body cap to the camera body and a front and rear lens cap to the lens when storing them to prevent dust from getting inside the body or on the lens surfaces. Remove the batteries before storing the camera for an extended period of time.

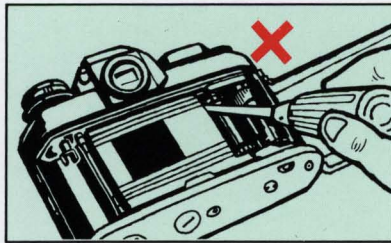

6. Never attempt to disassemble or repair the camera yourself.

These delicate procedures should be left to an authorized repairman.

SPECIFICATIONS

Type of camera	35mm single-lens reflex
Picture format	24mm × 36mm (standard 35mm film format)
Lens mount	Nikon bayonet mount
Lenses	Nikkor 50/1.2, 50/1.4, 50/1.8, and Nikon Series E 50/1.8 as standard; more than 55 Nikkor and Nikon Series E lenses available
Shutter	Horizontal-travel, titanium focal- plane shutter
Shutter speeds	Auto: Electromagnetically con- trolled stepless speeds from 8 to 1/2000 sec.; Manual: Quartz/ electromagnetically controlled discrete speeds from 8 to 1/2000 sec., plus B and X (1/80 sec.); mechanical: T setting on shutter speed dial and 1/60 sec. when using backup mechanical release lever
Shutter release	Electromagnetic shutter release; initial pressure on shutter release button switches on meter (after power switch is turned on), meter then remains on for 16 sec. after finger is taken off button
Backup mechanical release lever	Trips shutter at 1/60 sec. regard- less of shutter speed dial setting except at T; used when batteries are dead
Self-timer	Quartz-timed 10 sec. delayed exposure; LED blinks at 2Hz for first 8 sec. then at 8Hz for last 2 sec.

Exposure control	Aperture-priority automatic exposure with manual override and backup mechanical control; through-the-lens, full aperture metering via silicon photo diode (SPD) with center-weighted metering pattern and metering circuits incorporated into camera body; meter works with all viewfinders
Film speed range	ASA 12 to ASA 6400
Metering range	EV 1 to EV 18 at ASA 100 with f/1.4 lens
Exposure compensation dial	Provided; ±2 EV in one-third increments
Exposure memory lock	Provided; operates on Auto to electronically lock in shutter speed
Accessory shoe	Provided; special Nikon type located at base of rewind knob; accepts Nikon SB-12 shoe- mounting electronic flash unit or TTL connecting cord from SB-11 for TTL direct flash output control using camera's SPD metering cell
Flash synchronization	Speeds up to 1/80 sec. with electronic flash; with SB-12, flash sync is automatically set to 1/80 sec. when shutter speed dial is set at "A," or 1/125 sec. or above; flash synchronizes with shutter speed set at slower shutter speed settings; threaded sync terminal

Auto flash control provided for off-camera or multiple flash photography TTL direct flash control governs SB-12's flash output using camera's SPD sensor; effective ASA range from ASA 25 to ASA 400

Viewfinder Interchangeable eyelevel pentaprism type DE-2 as standard; 0.8X magnification with 50mm lens set at infinity; virtually 100% frame coverage

Viewfinder display Liquid crystal display (LCD) shows shutter speed; on Auto, + 2000 indicates overexposure, - 8- underexposure; on Manual, M appears with + indicating overexposure, - underexposure, and - + correct exposure; LED ready-light glows when Nikon SB-11 or SB-12 Speedlight is completely recycled; aperture in use also shown through aperture-direct-readout (ADR) window

Viewfinder illuminator Provided; illuminates both liquid crystal display and ADR f/number

Film advance lever Wound in single stroke or series of strokes; 30° stand-off angle and 140° winding angle; shutter speed automatically set to 1/80 sec. until frame "1" for fast loading when shutter speed dial is set to "A" or 1/125 sec. and above

Frame counter Additive type, self-resetting

Film rewind Folding crank with rewind button in baseplate

Eyepiece shutter Provided; prevents stray light from entering viewfinder from the rear

Focusing screen Type K as standard; interchangeable with 19 other types

Depth-of-field preview button Provided; coaxial with mirror lockup lever

Reflex mirror Automatic instant-return type with lockup facility; incorporates air damper

Multiple exposure lever Provided; disengages frame counter for correct count

Camera back Hinged, interchangeable type; memo holder provided

Power switch Provided

Batteries Two 1.5V silver-oxide cells (Eveready EPX76, D76 or equivalent); when MD-4 motor drive is attached, camera gets battery power from batteries in motor drive

Dimensions 148.5mm (W) × 96.5mm (H) × 65.5mm (D)

Weight 700g with DE-2 Eyelevel Finder

IMPORTANT!

The camera body you have purchased is packaged separately from the lens. Before mounting the lens, check if it is capable of Automatic Maximum Aperture Indexing (AI) operation with your camera body by verifying that the lens' aperture ring is fitted with a meter coupling ridge as illustrated at the right. Note that the "AI" mark on the cover of the instruction sheet provided with AI Nikkor lenses is your assurance that the lens offers the AI feature.

If the lens is fitted with the meter coupling ridge, it is fully capable of full-aperture exposure measurement and automatic maximum aperture indexing; to attach it to the camera, follow the directions provided in the BASIC OPERATION section of this instruction manual.

If the lens is non-AI, stop-down exposure measurement is required with the camera body's meter coupling lever locked up; to lock up the lever, follow the directions in the "Meter coupling lever" section of CONTROLS IN DETAIL.

Note: The modification at reasonable cost of most non-AI Nikkor lenses having both an automatic diaphragm and meter coupling prong is available for the convenience of Nikkor lens users. For further information concerning lens modification, please contact your local authorized Nikon dealer.

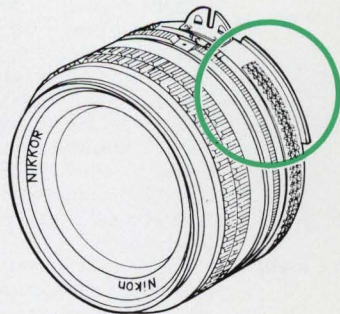
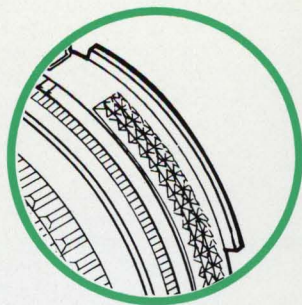



NIPPON KOGAKU K.K.

No reproduction in any form of this booklet,
in whole or in part (except for brief quotation in
critical articles or reviews), may be made without
written authorization from the publishers.

Printed in Japan (80. 1. B) &-1